

ご注意

組立説明書の内容を良く読んでから、
本図の印刷と制作を始めてください

部分は切抜く

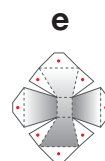

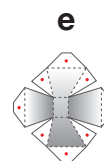
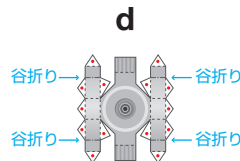
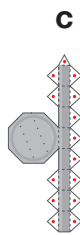
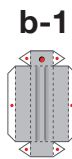
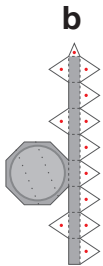
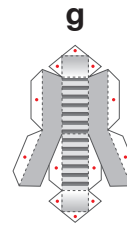
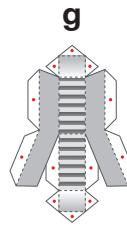
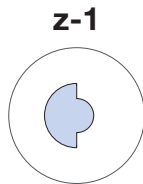
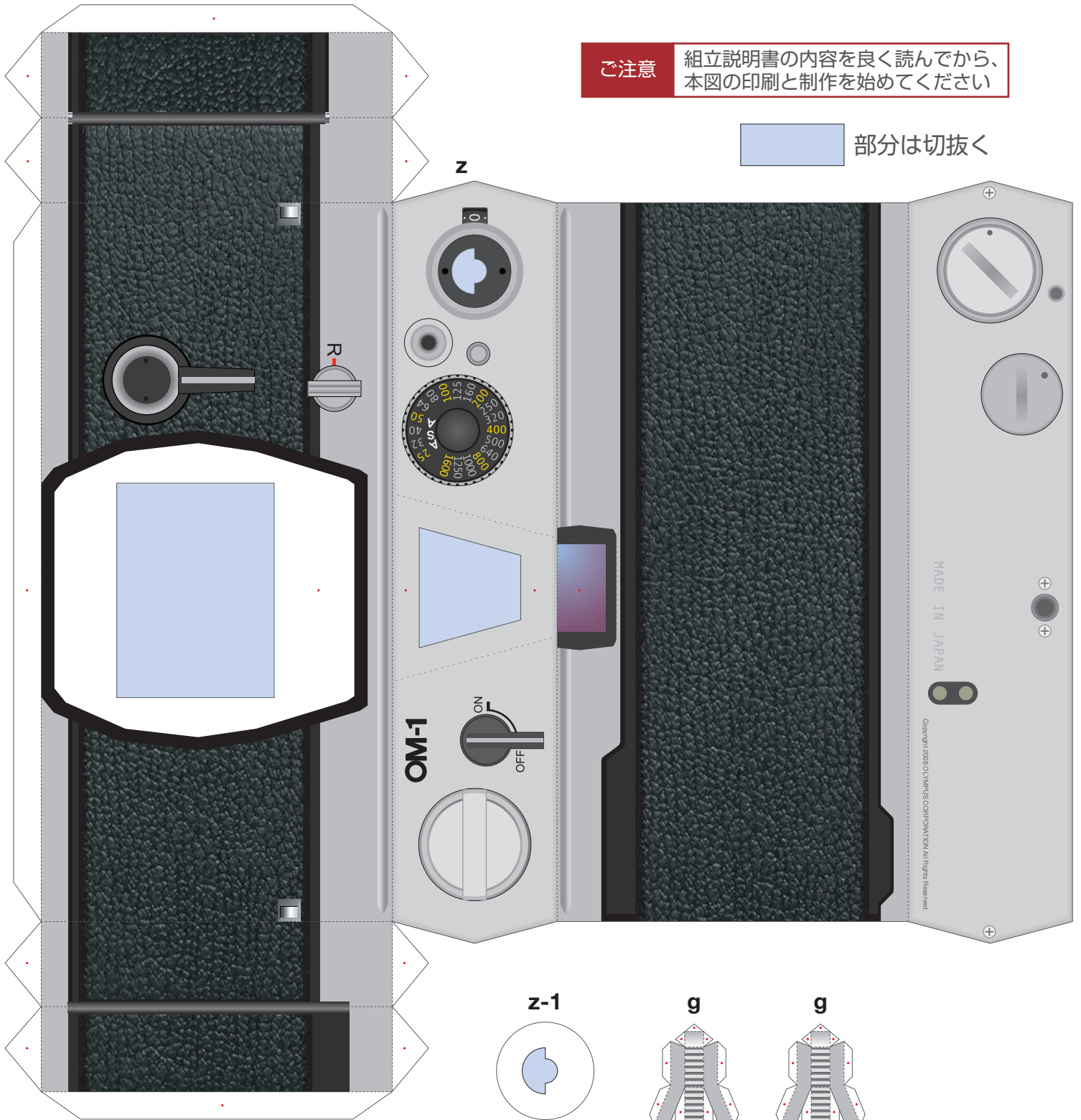
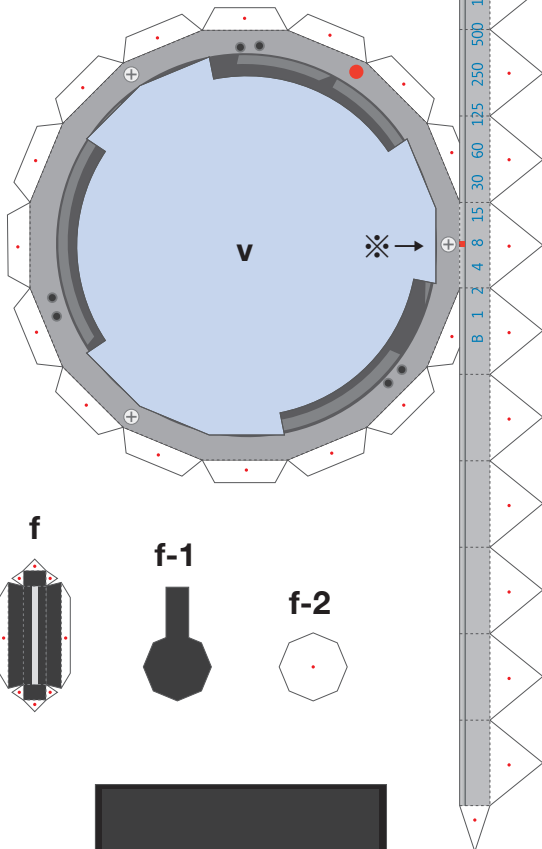
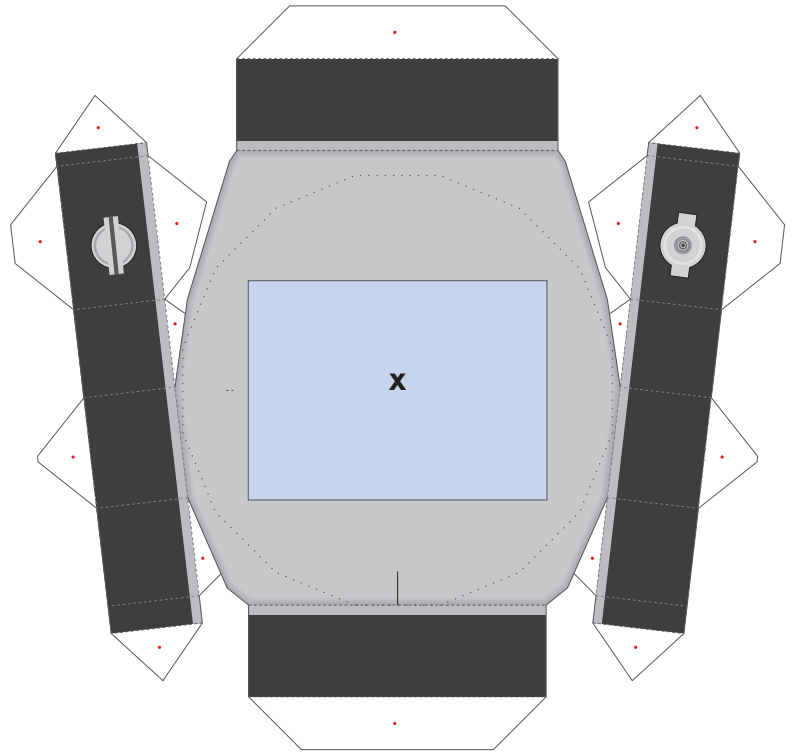
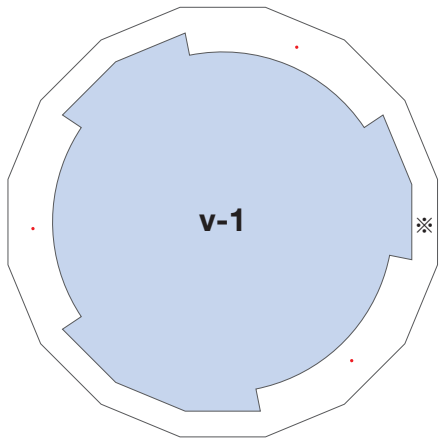

部分は切抜く

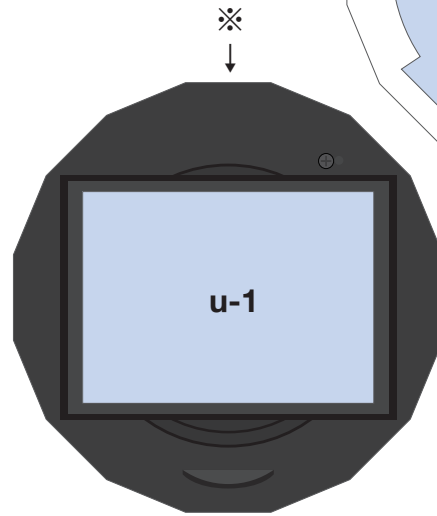
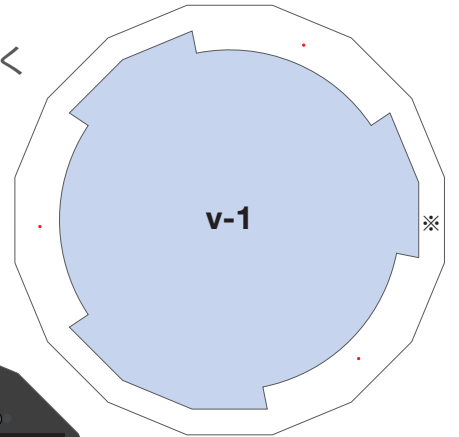

谷折り→

